



Saramad Sanat Isatis co.

Manufacturer of Airport, Terminal and Industrial equipment





Contents

Check-in Belt Scale (page 6)



Passenger Trolley (page 8)



Steel Barricade /
Crowded Control Barrier (Retractable Belt Stanchion) (page 10)



Queue Control Barrier
(Ceremonial Rope Stanchion) (page 12)



Roller Table for X-Ray Scanner &
Gravity Roller (page 14)



X-Ray Scanner Protection Box (page 16)



Bench (page 18)



Lounge Chair (page 20)

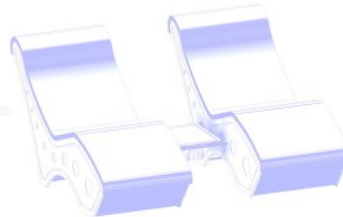

Security Control Desk / Boarding Counter (page 22)



Information Counter (page 24)



Check-in Counter (page 26)



Passport Control Desk (page 28)



Luggage Inspection Table (page 30)



Baggage claim Plate Carousel Conveyor
(page 32)

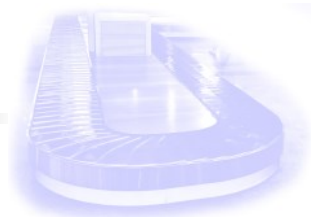

Linear Belt Conveyor (page 34)

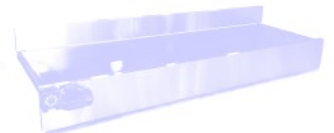

Corner Belt Conveyor (page 36)





“We do not claim that we are the best, yet we are glad that we are selected by the bests”

Saramad Sanat Isatis Co.

Airport, Terminal & Industrial Equipment Producer

After 18 years of hard work and experience in terms of producing airport equipment, the Saramad Sanat Isatis Company is trying to take one step forward in advancing our dear country Iran by the help of our experienced engineers and staff. By so doing, we have done our best to produce Iranian products that make us independent of foreign products and services.

This complex, via employing the most up-to-date knowledge, mechanical and electronic machineries, product lines, color, quality control, the experience of expert engineers and personnel, established Saramad Sanat Isatis Company in 2013.

Isatis Company has made a huge progress to improve the advancement landscape of Iran by using perfect raw materials, producing high-quality products able to compete with foreign counterparts, and providing multiple direct and indirect job opportunities.

Isatis has analyzed the needs of airports and airlines to increase the quality of products. Besides, with the help of its innovative engineers and experts opinions, Isatis has continuously tried to reform and improve the quality of its products so that the final products can easily compete with the foreign counterparts.



ادعای کنیم که بهترینیم اما خریدیم که بهترین ما را برگزیده اند

شرکت سرآمد صنعت ایساتیس (سهامی خاص)

تولید کننده تجهیزات فرودگاهی، ترمینالی و صنعتی

پس از ۱۸ سال تلاش و تجربه در زمینه تولید و راه اندازی تجهیزات و اجرای پروژه های فرودگاهی با تکیه بر دانش و تجربه مهندسی و کادر اجرایی زبده خود بر آن شده ایم تا با تاسیس شرکت سرآمد صنعت ایساتیس در قالب یک واحد تولیدی و صنعتی گامی محکم در راستای پیشرفت و تعالی ایران عزیز برداشته و با تولید محصولات با کیفیت میهن خود را از تولیدات خارجی بی نیاز سازیم.

این مجموعه با الهام از دانش روز و به کارگیری ماشین آلات مکانیکی و الکترونیکی، خطوط تولید، رنگ، کنترل کیفیت و استفاده از تخصص و تجربه مهندسی و پرسنل جوان و خلاق خود سرانجام در خردادماه سال یک هزار و سیصد و نود و دو اقدام به تاسیس شرکت سرآمد صنعت ایساتیس نمود.

این شرکت تولیدی با بهره گیری از مواد اولیه درجه یک، علاوه بر تولید محصولاتی با کیفیت و قابل رقابت با نمونه های خارجی با ایجاد فضای رقابتی سالم و همچنین فراهم سازی چندین فرصت شغلی به صورت مستقیم و غیرمستقیم گامی دیگر در راستای چشم انداز توسعه و موفقیت میهن عزیز خود برداشته است.

ایساتیس با بررسی نیازهای فرودگاهها و ایرلاین ها و با هدف بهبود کیفیت محصولات و به پشتوانه مهندسان خلاق و مجرب و با اعمال نکات مورد نظر کارشناسان شرکت فرودگاهها و ناوبری هوایی ایران، همواره در حال اصلاح و ارتقای کمی و کیفی تولیدات خود بوده که در این راستا، هر محصول عملیات علیهمده ای را به خود اختصاص داده بطوریکه طرح نهایی محصول، مآید این کلام بوده و قابل رقابت با نمونه های خارجی می باشد.



Airport Luggage Scale Belt Conveyor

Code: M11030



Product National Number
(Iran Code):

2531330-90385-0001



Technical Specifications:

1. Scale capacity: 400 kg
2. Equipped with 4 weighing load cells
3. Lower height of the front section of scale, for the sake of passenger convenience (equal to 28cm)
4. Side walls material: Iron with 1.5mm thickness and electrostatic color covering
5. High quality of steel work and finishing surfaces
6. Adjustable speed of scale belt 12 m/min
7. Minimum drive motor capacity of conveying scale: 150 Kg
8. Length of scale belt: 2m / effective width of scale entrance: 75cm
9. Material of belt is PVC with polyester backing and thickness of 2mm
10. Equipped with inverter system for reducing Depreciation & smooth performance, etc.
11. Weight: 211 kg

Mash'had Airport

فرودگاه مشهد- ترمینال ۲





Passenger Aluminum Trolley

Code: M22010



2334000903850001



Product National Number
(Iran Code):

2334000-90385-0001



isatis MultiMedia Manual

The logo means:

This product has VCD Manual



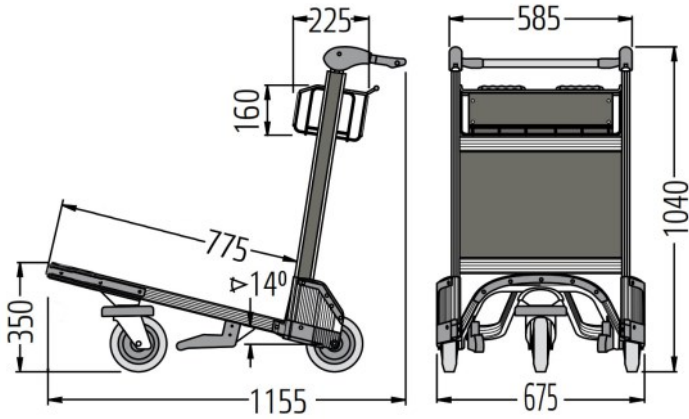

Technical Specifications:

1. Dynamic load carrying capacity: 250 Kg
2. Static load carrying capacity: 400 Kg
3. Material: Anodized Aluminum Alloy 6063 Series
4. Weight: 19.2 Kg
5. Reliable due to the active brake status while in normal mode (the brake would be released once the lever is pressed down)
6. Quality of the product is in compliance with European standard
7. The product provides suitable space for installation of promotional and advertisement stickers
8. Light & beautiful design and long life-span
9. Equipped with a basket with capacity of 15 Liters
10. Very little storage space (about 26.5 cm)

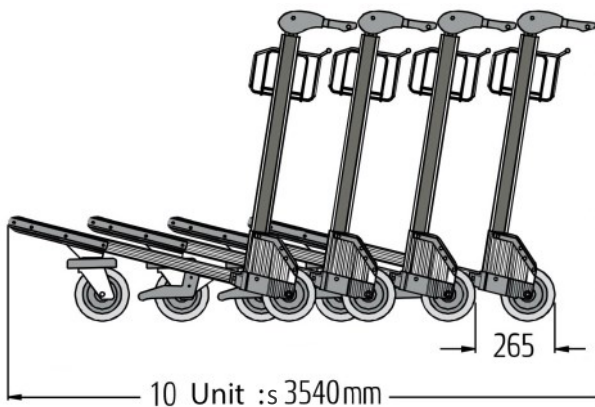

Iran Airports Company (project of 3000 units)

اجرای پروژه مناقصه ۳۰۰۰ عدد چرخ دستی شرکت فرودگاهها و ناوبری هوایی ایران





Steel Barricade

Code: M33010

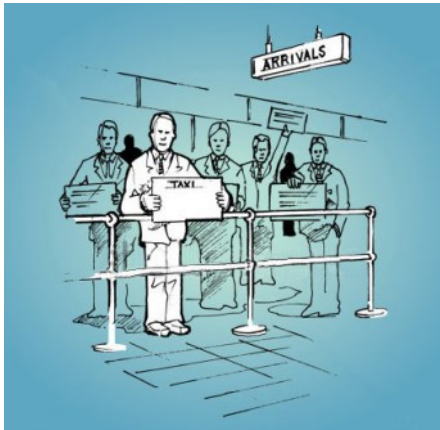

1172200903850001



Product National Number
(Iran Code):

1172200-90385-0001

Crowd Control Barrier

(Retractable Belt Stanchion)

Code: M33210



1172200903850002



Product National Number
(Iran Code):

1172200-90385-0002





Technical Specifications of Crowded Control Barrier:

1. Balancing Plate: diameter 30 cm, thickness 1.5 cm
2. Balancing Plate weight: **8.4 kg**
3. Total weight: **11 kg**
4. Post height: 88 cm
5. Belt length: 190 cm
6. Material of Base Plate & Pole: SAE 304 stainless steel
7. Accepting orders for exclusive print of advertisements on belt

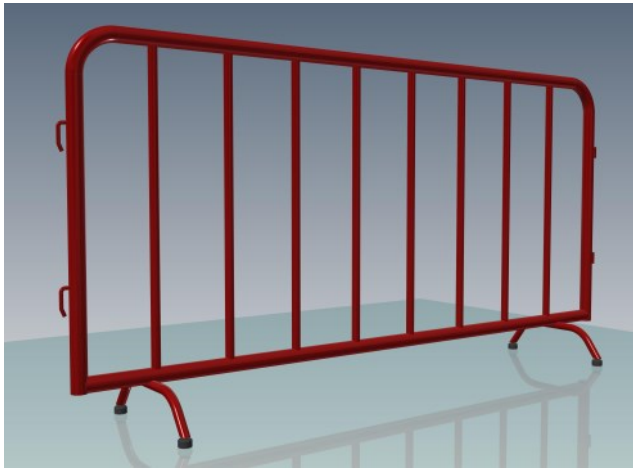

Technical Specifications of Steel Barricade:

1. Barricade height: 75 cm
2. Length: 180 cm
3. Material: 304 stainless steel
4. Pipe diameter: 25 , 38 and 51 mm (with thickness of 1.25 and 1.5 mm)



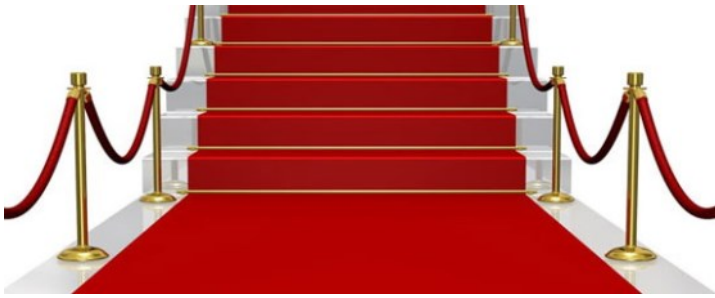

Queue Control Barrier

(Ceremonial Rope Stanchion)

Code: M33410



Product National Number
(Iran Code):

1172200-90385-0003



**Technical Specification:**

1. Balancing Plate: diameter 30 cm , thickness 1.5 cm
2. Balancing Plate weight: **8.4 kg**
3. Weight of each post without rope: **11.2 kg**
4. Post height: 100 cm
5. Rope length: 150 cm Material: Braided Silk
6. Material of Base Plate & Pole: SAE 304 stainless steel
7. Beautiful design



Roller Table for X-Ray Scanner / Gravity roller

Code: M44 series



Product National Number
(Iran Code):

3825120-90385-0002

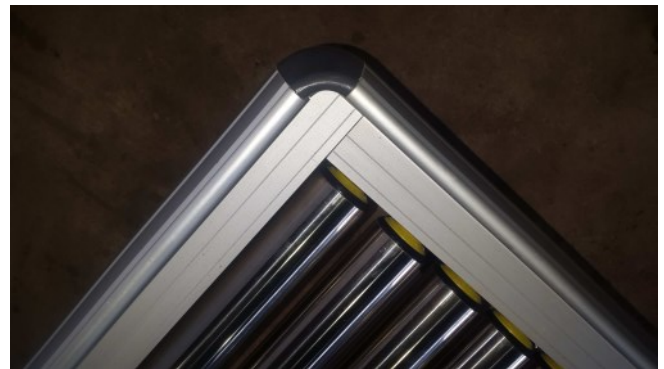
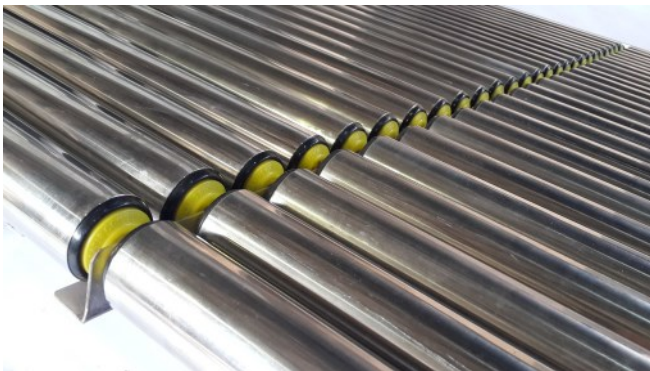

Technical Specifications for Roller table of X-Ray Scanner:

1. Chassis material for 6030, 6040, 7555, 522 and 622 models:
Aluminum with Custom-Built profile (M44000 series)
1. Material of 9075, 100_100 and 528 models: **Steel** (M44200 series)
2. Length depending on order ranging from 0.5 to 3 meter
3. Distance between rollers: 5 mm
4. Rollers material: SAE 304 stainless steel, Diameter 51 mm, thickness 1.25 mm
5. Easily replaceable rollers (convenient replacement of rollers)
6. Legs with adjustable height
7. Width and height of rollers varies according to the X Ray Scanner model

Imam International Airport (IKIA)- SALAM Terminal

فرودگاه امام- ترمینال سلام





X-Ray Scanner Protection Box

Code: M44600



**Technical Specifications:**

1. Body material: transparent acrylic, 10mm thickness
2. Chassis material: steel
3. Possibility of engraving a custom logo on acrylic side walls
4. Dimensions varies according to the X-Ray scanner model

Gorgan & Mash'had Airports Project

پروژه فرودگاههای گرگان و مشهد

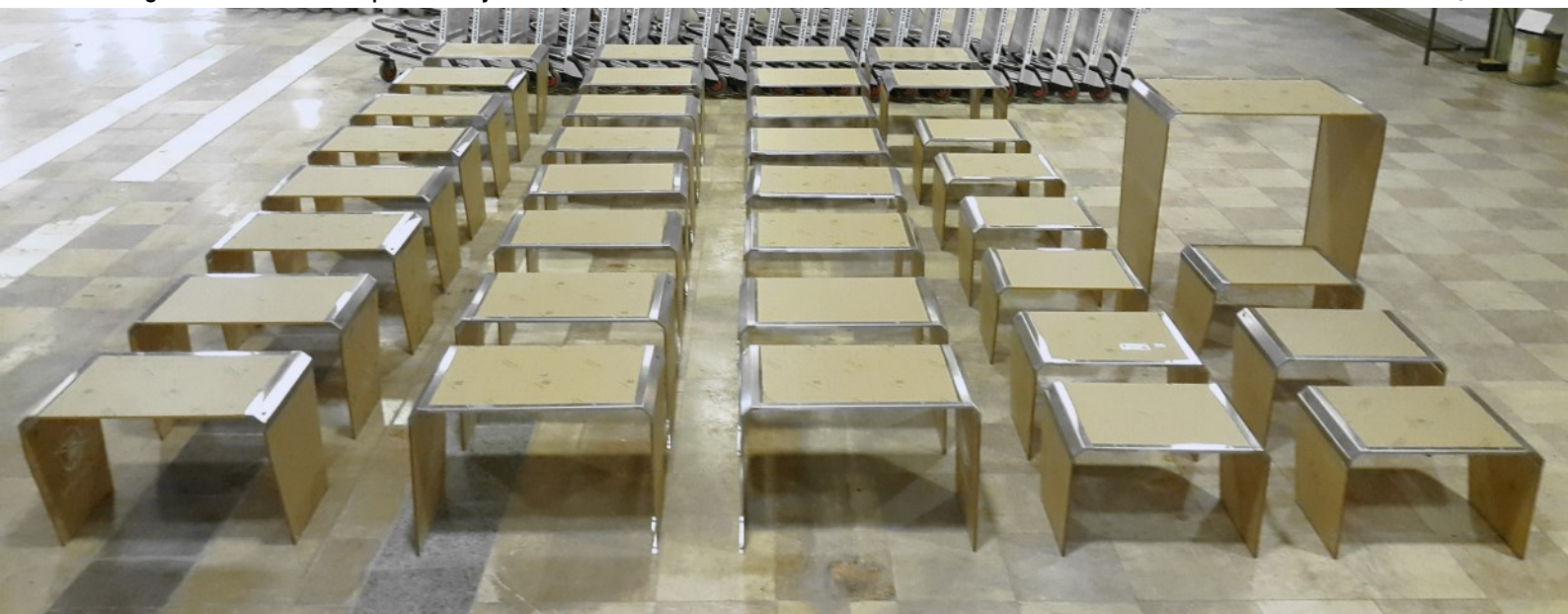



Bench (Waiting Chair)

Flight model

Code: M66000 series

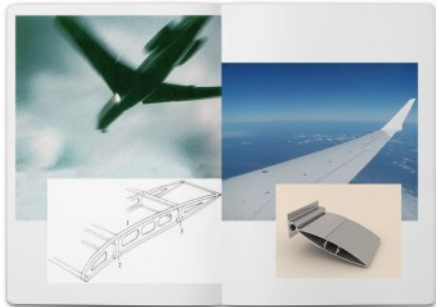

Sections of waiting chairs profiles are similar to airplane's wings in design and material; regarding this resemblance, the waiting chair series are named as "Flight".



1111100903850001



3 seats series
Product National Number
(Iran Code):

1111100-90385-0001



1111100903850002



4 seats series
Product National Number
(Iran Code):

1111100-90385-0002





Seat length without table* (m)	Number of seats
1.25	2
1.87	3
2.49	4
3.11	5
3.73	6
4.35	7
4.97	8

* table length: 38 cm

Technical specifications:

1. Material: Anodized extruded aluminum profiles
2. Available in various lengths from 2 seats up to 8 seats according to the following table
3. With only 2 legs regardless of the bench length
4. With different designs including standing benches and wall mounted benches
5. Modern European design, winner of 8 awards for design in Europe and USA

Optional selection of bench set based on following table:

<ul style="list-style-type: none"> • Without Power outlet • With power outlet under the seat • With power outlet under the armsets 	<ul style="list-style-type: none"> • Without table • With 1 table on one side of the chair • With two tables on both sides 	<ul style="list-style-type: none"> • Without seat pads • With seat pads (back and seat pads) 	<ul style="list-style-type: none"> • Without armset • With only two armsets on both ends of bench • With full armsets for each seat
---	---	--	--



Standing Bench



Wall mounted Bench

Mash'had Airport project

پروژه فرودگاه مشهد





Lounge Chair

Code: M66220



Product National Number
(Iran Code):

1111100-90385-0003

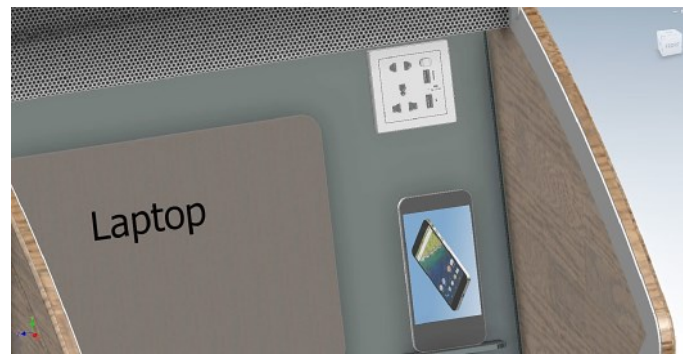

Technical Specifications:

1. This product can be ordered having a single chair or having a series of chairs (2, 3, 4 or 5 and more seats depending on the order)
2. Length of chair 175 cm, width 60 cm, minimum bottom height 41 cm, Total height 92 cm, height of middle table 32 cm, total width of chair and table altogether (side to side distance) 100 cm
3. 2.5cm thickness Mattress, with 60-cm. width leather-pattern covering
4. Side walls material: MDF with thickness of 16 mm. and with vacuum veneer pattern according to the order
5. Solid body design thanks to internal metallic chassis and use of metallic cross-linked joints
6. Equipped with suitable interior compartment for keeping bag(s) and other personal belongings while resting and subsequently preserving their safety
7. Equipped with any-stop door lift gas struts for ease of use and passenger safety
8. Equipped with power outlets accessible from both outside and inside the compartment
9. Weight of single chair together with the table: 57 Kg

Isfahan Airport project

پروژه فرودگاه اصفهان





Passport/Boarding Counter

Code: M77210



Product National Number

(IranCode):

1175220-90385-0010



Technical specifications:

1. Effective dimensions of the counter:
2. Length: 77 cm Width: 70cm Height: 115 cm
3. Counter body material: CNC cut, 16mm Standard MDF, covered with vacuum press PVC.
4. In order to prevent any vibration, creaks or squeaking sound, the structural framework of the internal closet is made out of MDF, manufactured and assembled separately and finally installed and fixed into the main frame of the counter in its proper position.
5. The counterman desk, lower desk and upper desk (crown) of the counter is made out of Corian (antibacterial acrylic solid surface).
6. Weight: 72 kg

Imam International Airport (IKIA)- SALAM Terminal

فرودگاه امام- ترمینال سلام





Information Counter (Help Desk)

Code: M77610



Product National Number
(IranCode):

1175220-90385-0012



Technical Specifications:

1. The overall design of the counter: customizable
2. The general dimensions of the counter: Height: 120 cm / Length: as ordered / Width: 60 cm / Height of the counter desk: 75 cm
3. Main frame of the desk is made out of the structural Rectangular Hollow Section (RHS) 20 X 40 profiles, and the whole exterior side of the counter body is made out of the standard 8 mm MDF covered with 1mm thick steel sheet.
4. The front view body of the counter, countertop desk and armrest ribbon of the counter are manufactured from Corian (antibacterial acrylic solid surface) and their colors are customizable as ordered by the customer to match with the theme of the environment.
5. At the front side of the counter, a rigid and durable Corian counter desk is mounted to withstand the weight of the passenger bag.
6. Depending on the installation environment and position, the counter can be designed and manufactured to be 1-sided (mounted beside the wall), 1.5-sided (such as the one presented in the SALAM terminal project), 2-sided (mounted on the corner of the salon), 3-sided (mid-hall design), or 4-sided (island mid-hall design), upon to the customer's request.

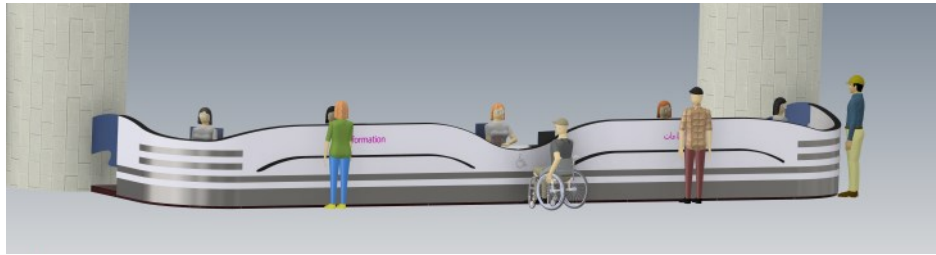

Imam International Airport (IKIA)- SALAM Terminal

فرودگاه امام- ترمینال سلام





Check-in Counter

Code: M77000 series

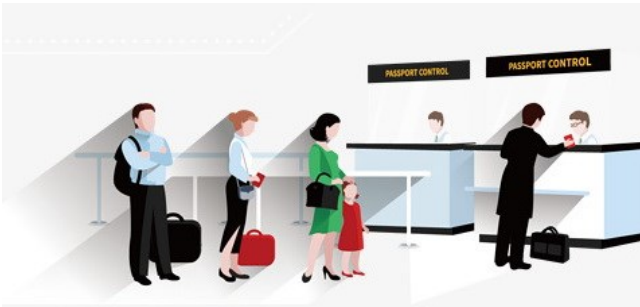

Single stand
Product National Number
(Iran Code):
1175220-90385-0008



Double stand
Product National Number
(Iran Code):
1175220-90385-0009



Technical Specifications:

1. The counterman desk, upper and lower passenger desks and front wall produced from classy Corian (Solid Surface) (made in Korea)
2. Body covered by striated and coated SAE 304 stainless steel material
3. Highly resistant multi wall body (combination of steel, cast iron chassis and two layers of MDF sheet)
4. Built-in installation of Counterman and passenger display screens (in case of ordering the counterman together with scale)
5. Available in curved and flat designs
6. Use of proper spacing in design of closet and drawers, compliance with standard dimensions for specific printer location, approved by Iran Airports Company
7. Weight of Single stand counter: 200 Kg / effective width: 120 cm
8. Weight of Double stand counter: 290 Kg / effective width: 180 cm

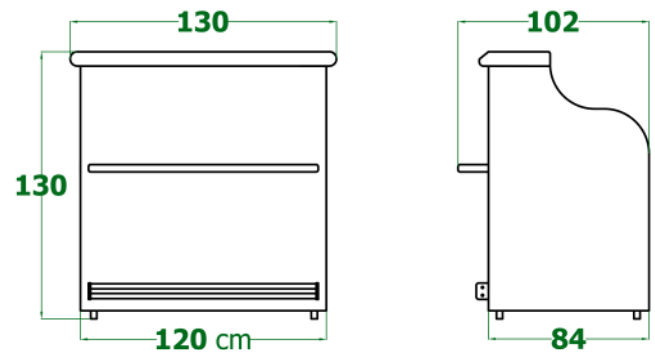

Imam International Airport (IKIA)- SALAM Terminal

فرودگاه امام- ترمینال سلام





Passport Control Desk



Product National Number
(IranCode):
1175220-90385-0011

Code: M77420 - Pedal



Technical specifications:

1. The counterman desk, upper and lower passenger desks and front wall are produced from classy Corian (Solid Surface) (made in Korea)
2. Body covered by: SAE 304 stainless steel
3. Highly resistant multi-wall body
4. Dimensions of Single stand counter: 1.5 x 1.5 m
5. Dimensions of Double stand counter: 1.5 x 3 m
6. All-round upper walls are made from Tempered glass with 10mm thickness
7. All-round Lower lines are made from Custom-Built Aluminum profile.



Code: M77410 Simple model

Maku Airport

فرودگاه ماکو





T model
Product National Number
(Iran Code):
1175220-90385-0006



Cubic model
Product National Number
(Iran Code):
1175220-90385-0007



Old design inspection table - T
model Code: M77820



Technical specifications of T model:

1. Dimensions: length 180cm, width 80cm, height 75cm
2. Equipped with reinforced iron chassis, 8 mm MDF and finally covering with SAE 304 steel
3. Upper Surface: 16 mm MDF with double Layer all around 13cm margin (32mm Thickness) and covering with SAE 304 steel
4. In order to prevent damages to the passenger's bag, corners of the table are rounded and free of sharp and cutting edges.
5. Height of Legs under the chassis of table are adjustable.
6. Weight: 103 kg



Bandar Abbas Airport project

پروژه فرودگاه بندر عباس

Technical specifications of Cubic model:

1. Dimensions: length 170cm, width 80cm, height 75cm
2. Chassis made from Custom-Built Steel304 profile.
3. Body material: combination of steel & Coated MDF , Color in order
4. Upper Surface: 16 mm MDF with double Layer all around 13cm margin (32mm Thickness) and covering with SAE 304 steel
5. In order to prevent damages to the passenger's bag, corners are chamfered.
6. Height of Legs under the chassis of table are adjustable.
7. Chassis and Body all made of steel with 38kg weight without any iron material.
8. Weight: 85 kg



New design inspection table – Cubic
model Code: M77820



Baggage claim Plate Carousel Conveyor

Inclined

Code: M88210



Flat

Code: M88010



3825110903850004



Product National Number
(IranCode):

3825110-90385-0004



3825110903850003



Product National Number
(IranCode):

3825110-90385-0003



Flat Carousel Technical Specifications:

1. Dimensions: height: 53cm, width: 110cm, minimum distance between two lines: 116cm, minimum back to back distance of machine: 337 cm, Length: according to the order
2. Per each 40 m of the conveyor length, one motor unit is installed.
3. Electromotor of motor unit: 4 Kw, 1400 rpm, each individual motor is equipped with a separate inverter.
4. The carousel is equipped with spiral gearbox, gear ratio of 1/30 from high-quality brand of YILMAZ
5. Palettes on machine are made of anti-wear and silent compressed rubber.
6. The conveyor is equipped with emergency stop and pre-start alarm system

Mash'had Airport

فرودگاه مشهد- سالن ورودی





Linear Belt Conveyor

Code: M88400



Product National Number
(IranCode):

3825110-90385-0001

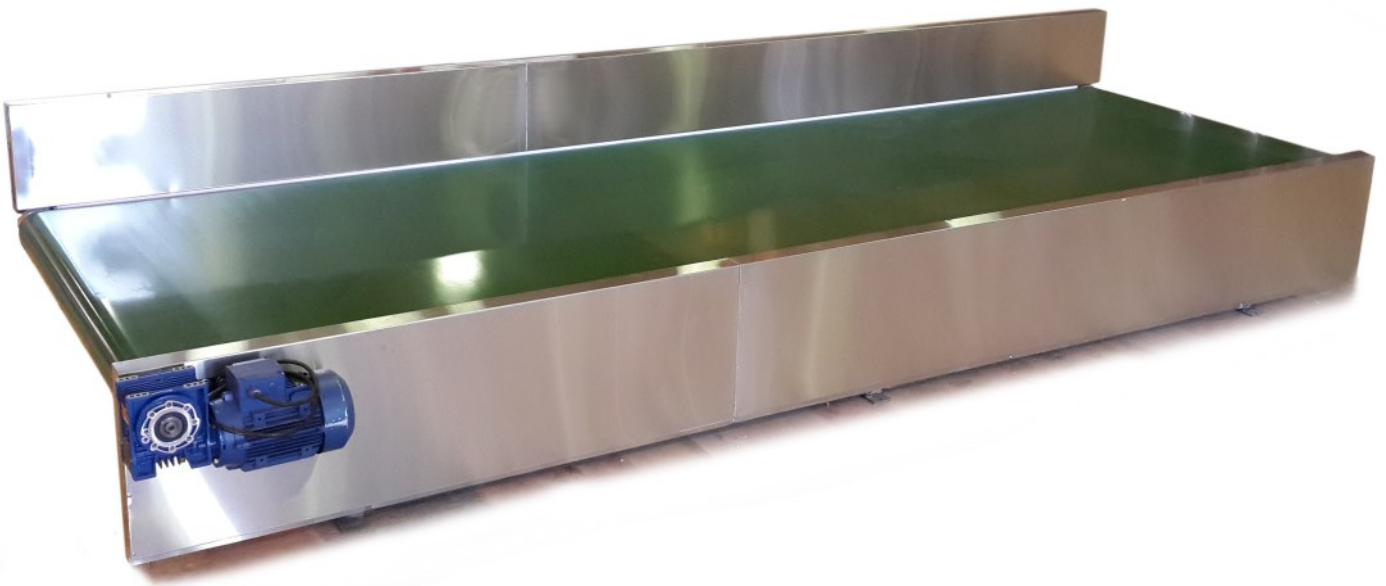

Technical Specifications:

1. Dimensions: height of the belt from ground is adjustable from 46 to 56 cm/ maximum side to side width 130cm
2. Speed of belt is adjustable from 0 to 20 meters per minute, and load carrying capability is equal to 80 Kg/m².
3. Electromotor and gearbox are directly coupled to each other and motor is equipped with in-verter
4. Power transmission roller has heated rubber covering with minimum thickness of 10mm
5. The conveyor belt is covered by 304 steel with 1.25mm thickness
6. The linear belt conveyor has some walls with height of 10 to 40cm. on one side or both sides in the required parts
7. 115cm. width belt, material is PVC with 2 Layers polyester and thickness of 3mm.
8. The linear belt conveyor is equipped with emergency stop and pre-start alarm system

Bushehr Airport

فرودگاه بوشهر

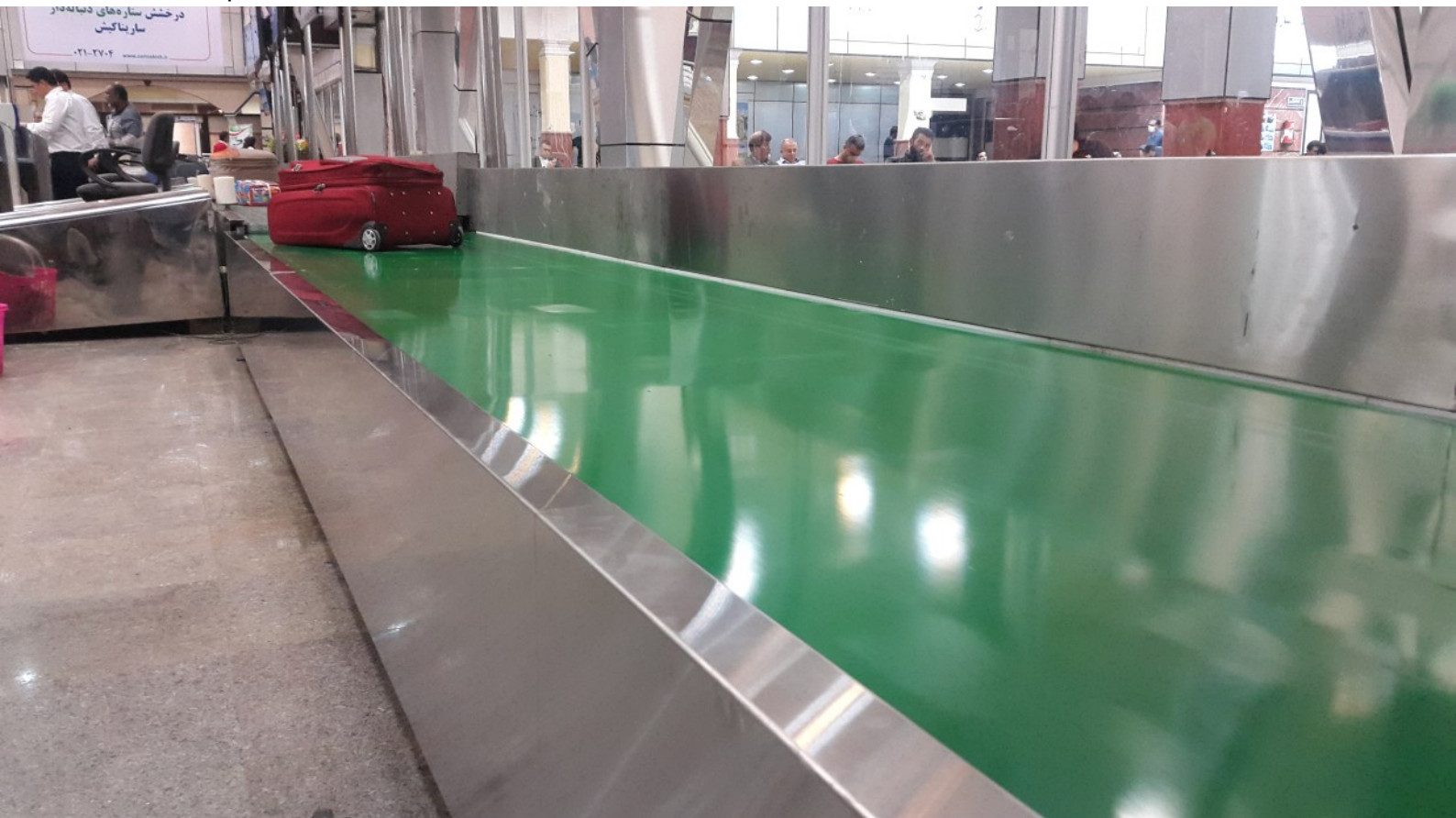



Corner Belt Conveyor (90 degrees)

Code: M88810



Product National Number
(IranCode):

3825110-90385-0002

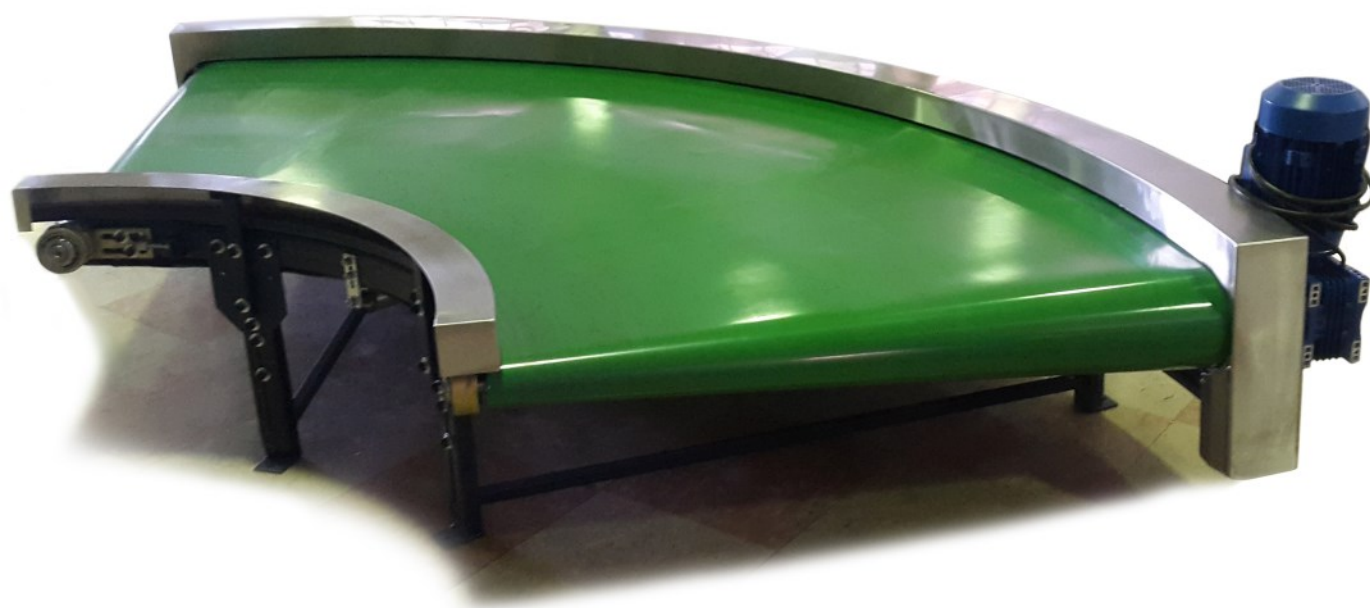

Technical specification:

1. Dimension of corner belt conveyor: Effective width of entrance: 115cm, Height: adjustable from 46 to 56 cm, Back to back distance: 210.5cm
2. Belt material is PVC with 2 layers polyester with thickness 3mm. in rubber-gelated backing.
3. Electromotor 1.5 kw with directly coupled gearbox and equipped with inverter system
4. Conveyor cover: non-magnetic steel, thickness 1.5 and 3 mm
5. Weight: 283 kg

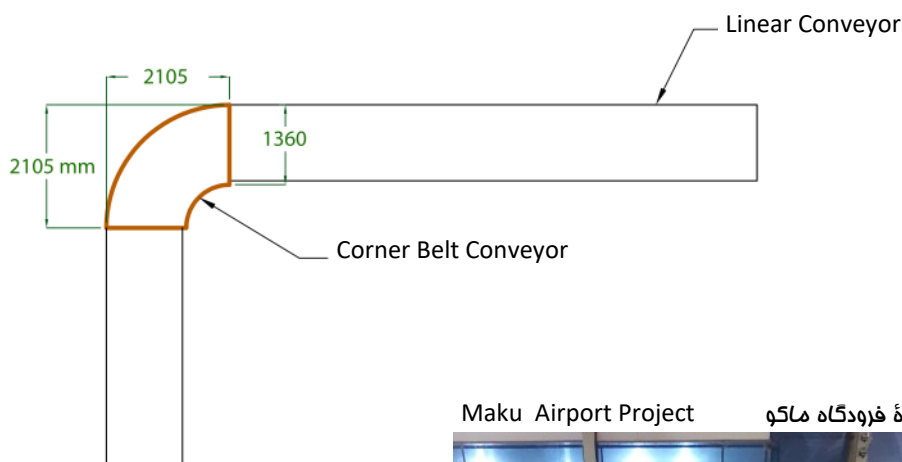

Maku Airport Project

پروژه فرودگاه ماکو

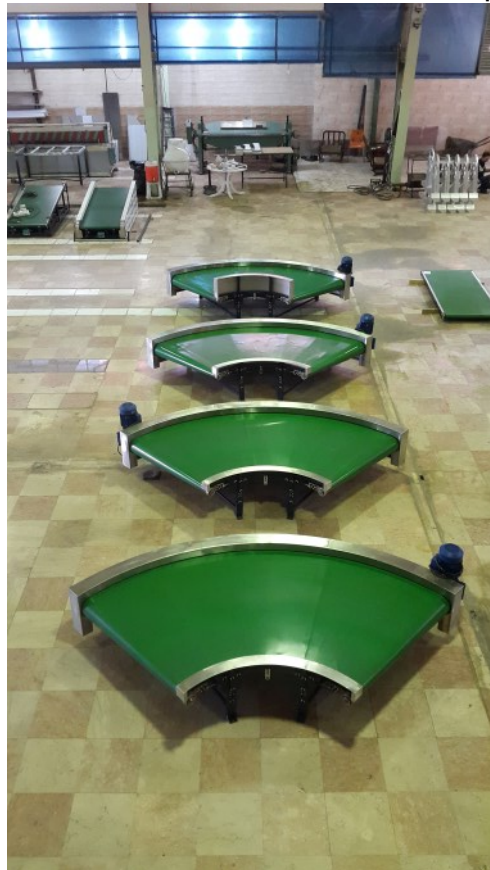

فهرست

باسکول توزین بار مسافر (صفحه ۶)



چرخ دستی حمل بار مسافر (صفحه ۸)



راه بند نرده ای / راه بند نواری (صفحه ۱۰)



راه بند طنابی (صفحه ۱۲)



رولیک ایکس ری & رولیک هرزگرد
انتهایی (صفحه ۱۴)



ممافا ایکس ری (صفحه ۱۶)



صندلی انتظار (صفحه ۱۸)



صندلی استرامت (صفحه ۲۰)

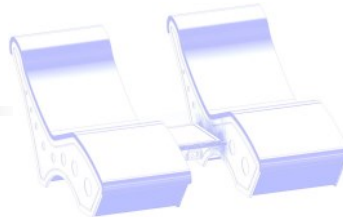

کانتر امراز هویت / کانتر بوردینگ (صفحه ۲۲)



کانتر اطلاعات (صفحه ۲۴)



کانتر پذیرش (صفحه ۲۶)



کانتر گذرنامه (صفحه ۲۸)



میز بازرسی (صفحه ۳۰)



نقاله پالتی دوار (صفحه ۳۲)



نقاله نواری فطی (صفحه ۳۴)

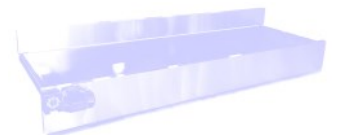

نقاله نواری کرنر (۹۰درجه) (صفحه ۳۶)



Airports covered by S.S.Isatis:

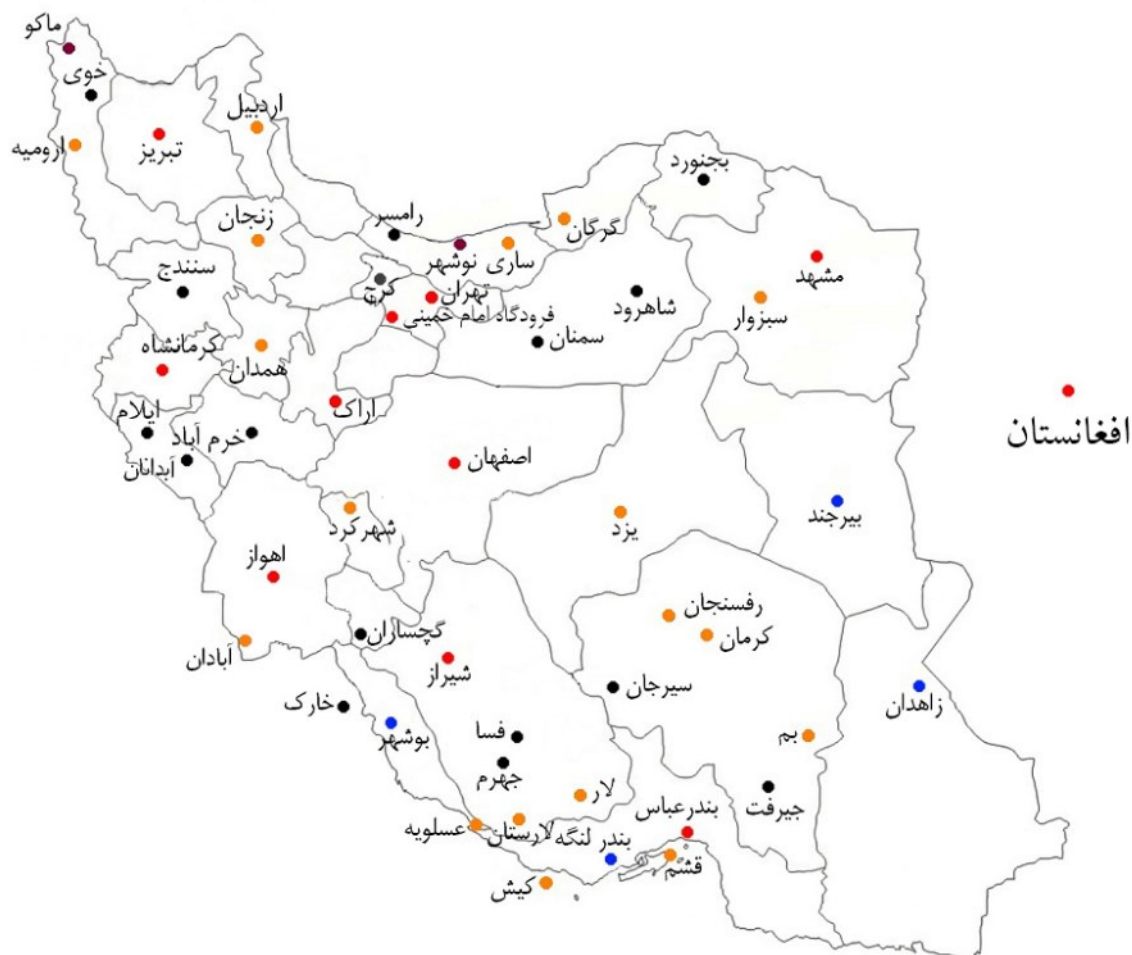

Other Customers :

Iran Post- ASTAN QUDS RAZAVI- Iran Central Bank- Petrochemical- Rail Road- Ministry of Defense and Armed Forces Logistics- Presidency- Iranian Red Crescent Society - IRAN KHODRO Diesel Company- MELLI SAKHTEMAN co. - National Iranian Oil Company- Kish investment and development company- Iran Airports Company- Iran University of Medical Sciences- SANANDAJ Water & WasteWater Co. - BUSHEHR General Administration of Ports and Maritime Affairs- Social Security Organization- West AZARBAYJAN General Directorate of Highways- ...



WebSite : www.isatisConveyor.com

Telegram Channel : @AirportEquipments

Telegram Contact : @isatisConveyor

Email: info@isatisConveyor.com
isatisBox@Gmail.com

Phone: 021-91014650

021-44992742

Mobile: 0910-7656952

Manager: 0912-2610953